

A	B	C	D
1	S383-0022	1284	534
2	S383-0023	606	534
3	S383-1037	1904	385
4	S383-1038	1904	385
5	S383-1039	1517	350
6	S383-2025	780	780
7	S383-2026	780	780
8	S383-3016	749	764,5
9	S383-3017	310	349
10	S383-3018	309	349
11	S383-4009	1904	764,5
12	S383-9012	1929	775
13	dr-418	418,	22

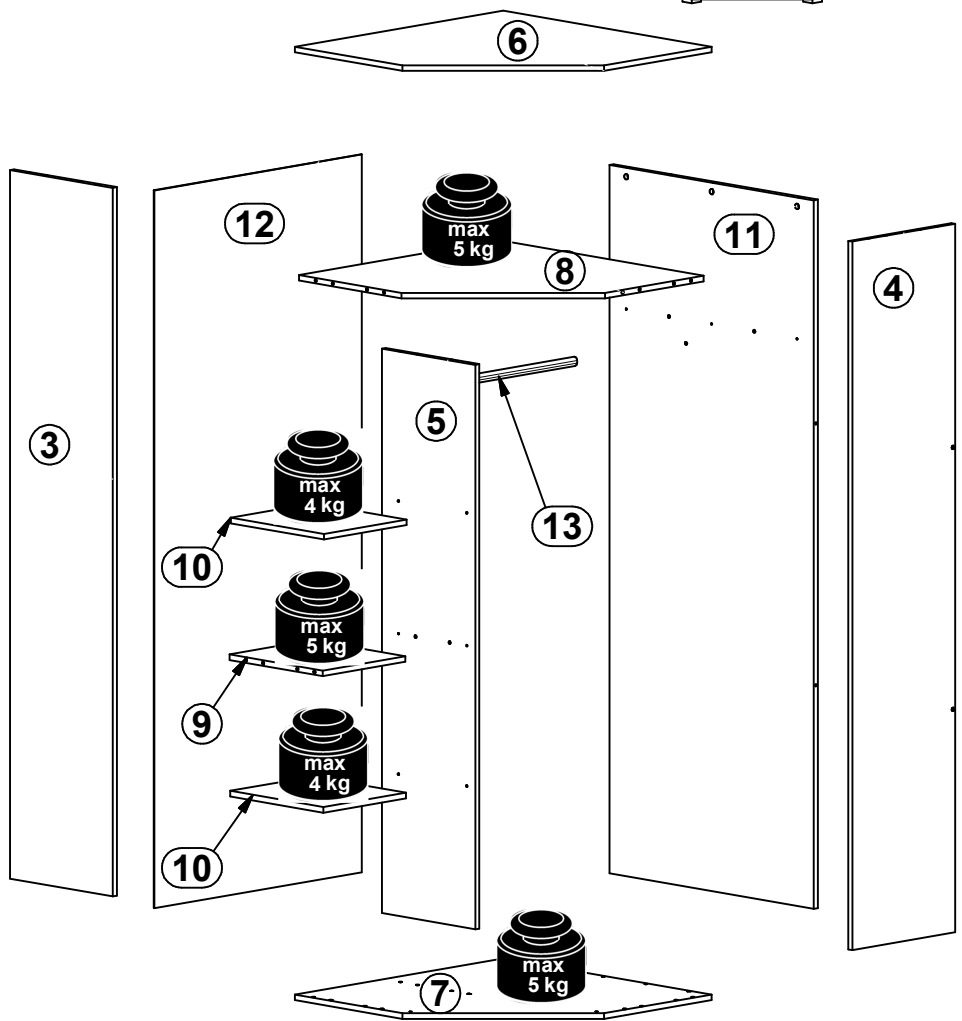

5x a10	5x b3	1x 128mm c409	8x d1 Ø5x17 mm	11x e1 Ø7x50 mm	10x e2 Ø6,3x13 mm	10x e3 Ø6x13 mm	26x f1 Ø8x30 mm	5x k82\1 Ø51 mm
5x 58x58\18 mm k82\2	80x 1,4x20 mm l1	2x h=22mm n1	1x n76	1x silikon o21	2x p1 Ø3,5x13 mm	1x d5 Ø6,3x15 mm	10x p51 Ø3,5x15 mm	6x p93 Ø4x13 mm
20x Ø15x12 mm #16 r1	20x 20/11 r42	2x s1	16x Ø16 s2	1x 4 mm z1	1x n26	1x p38 Ø3,5x16 mm		

1 

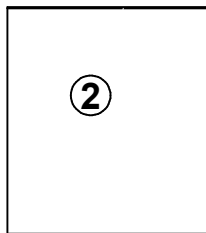
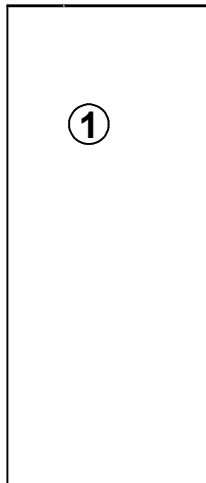
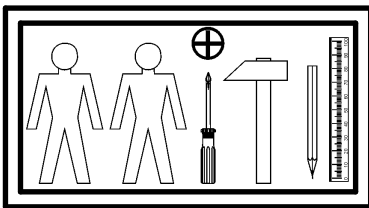
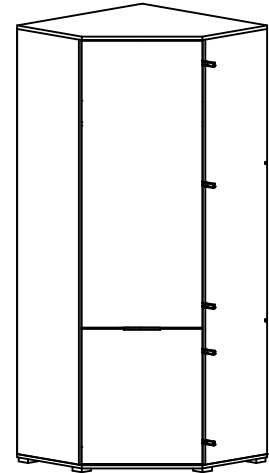
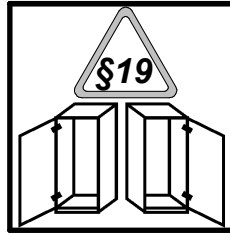
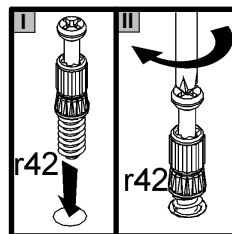
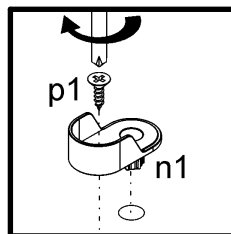
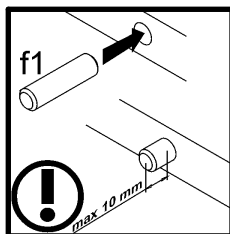
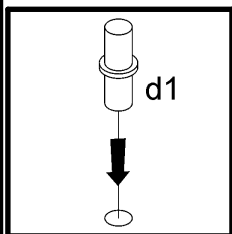
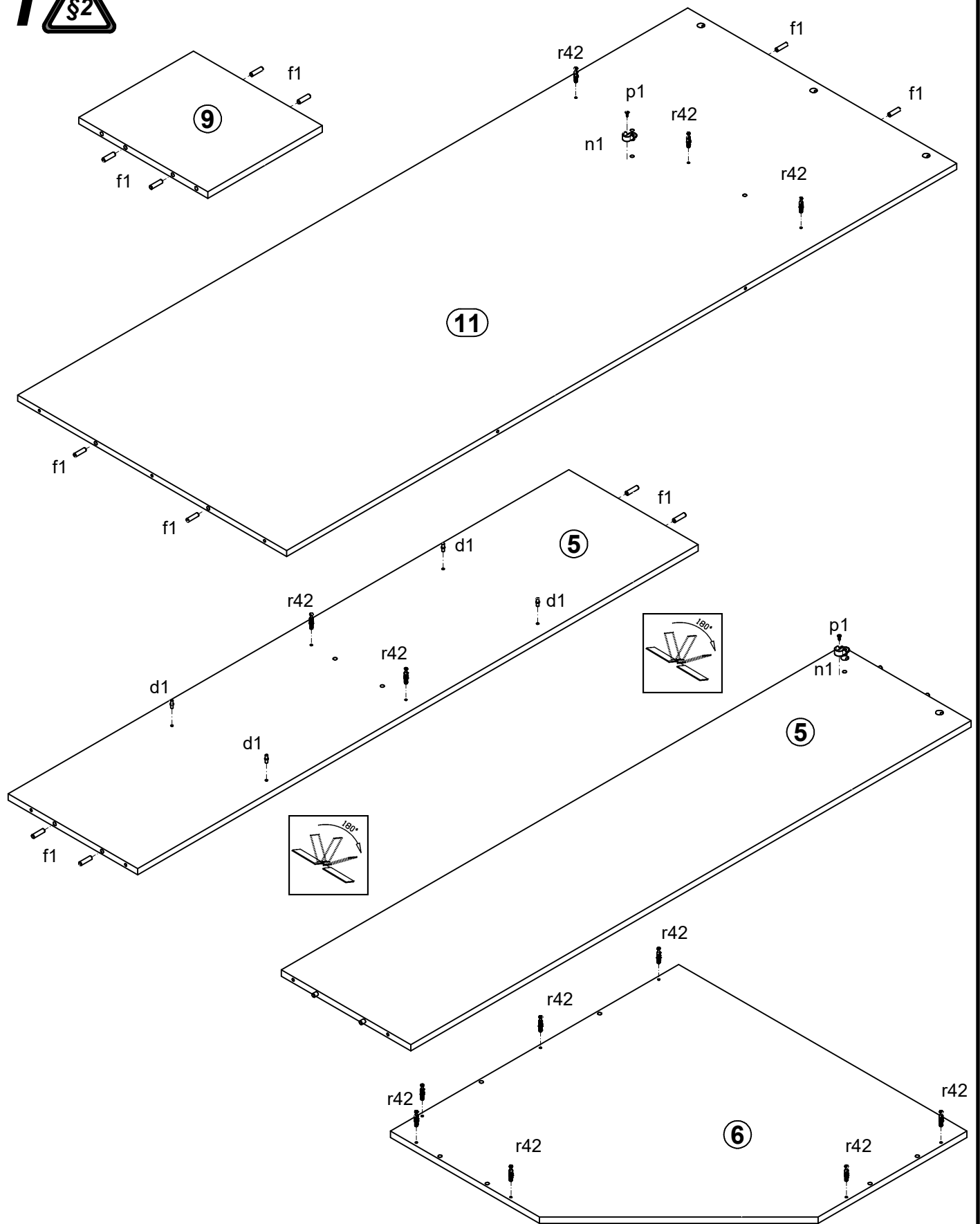

# 2

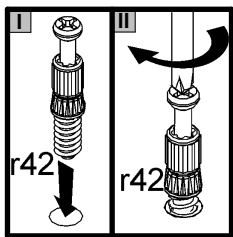
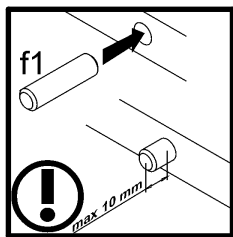
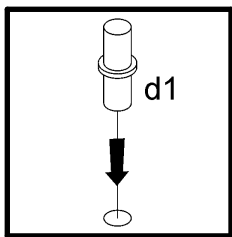
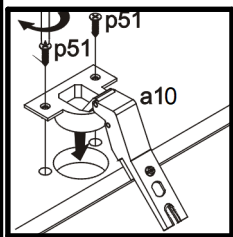
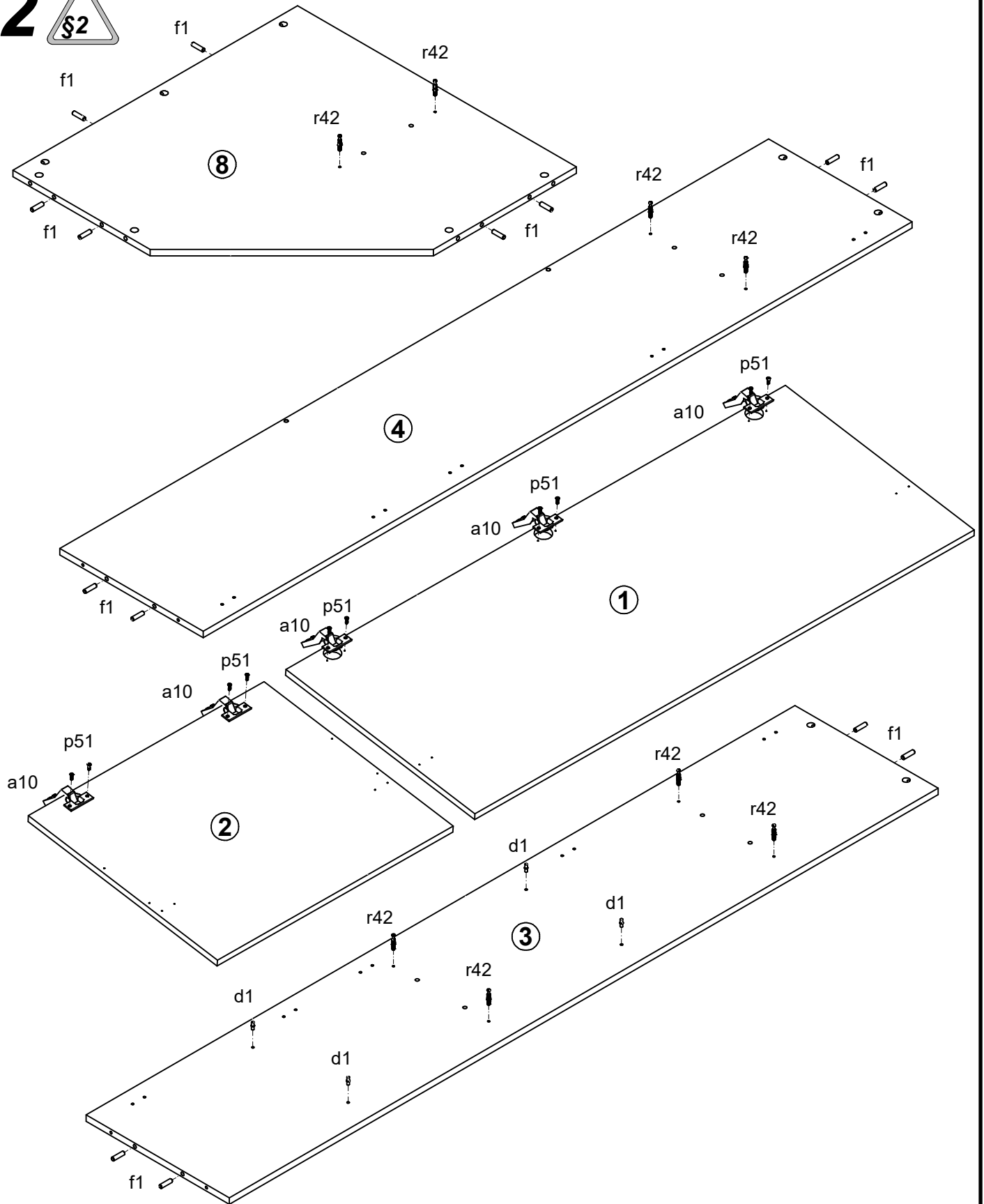

# 3

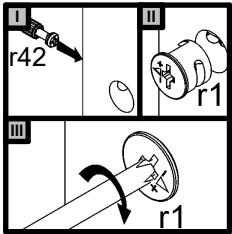
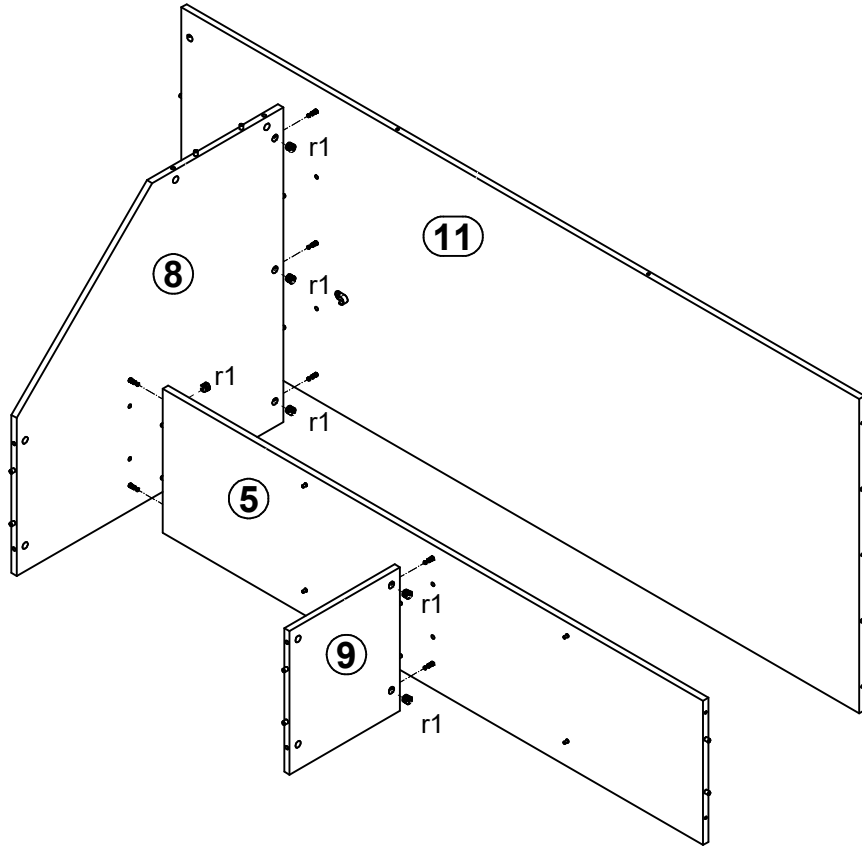

# 4

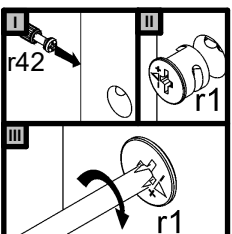
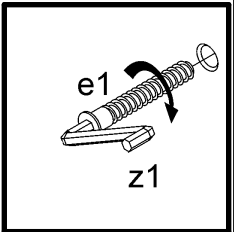
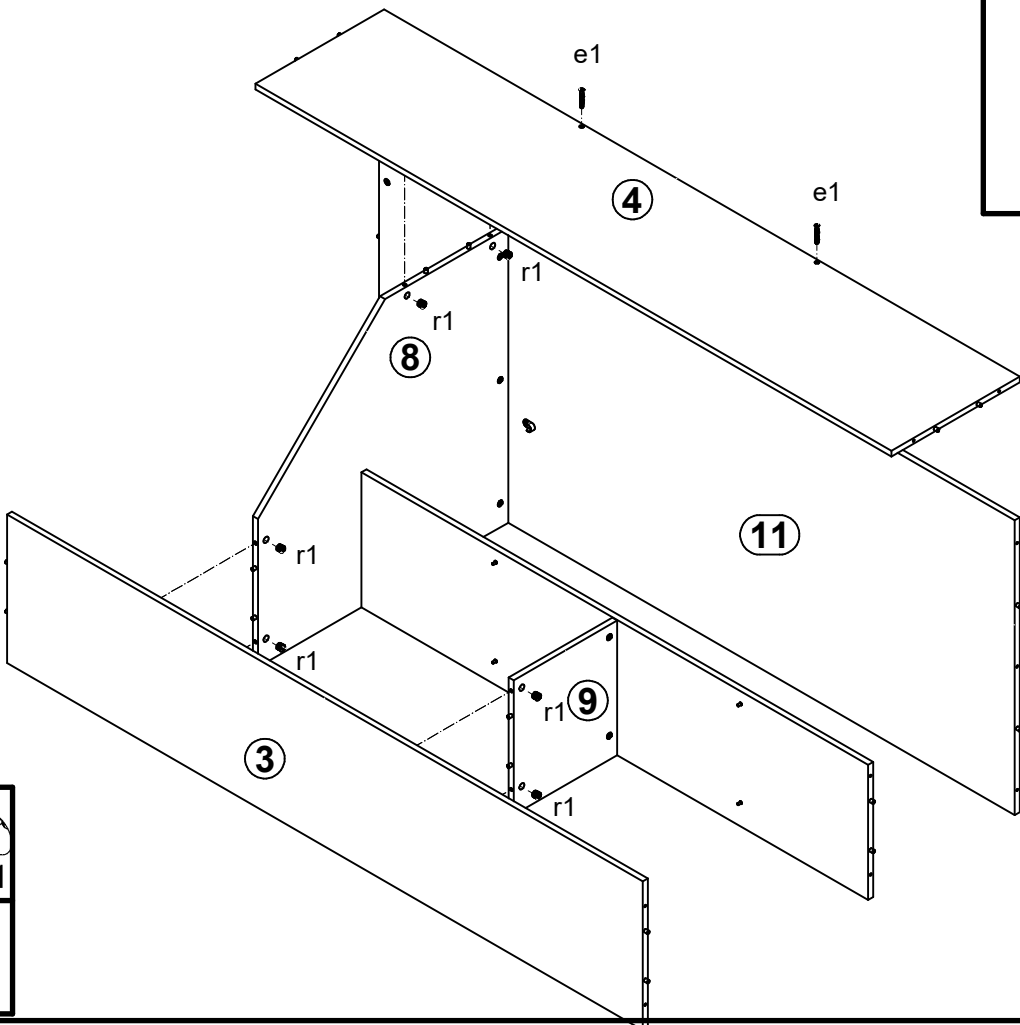

# 5

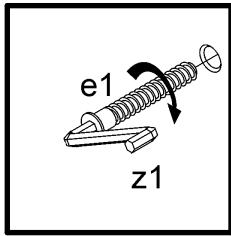
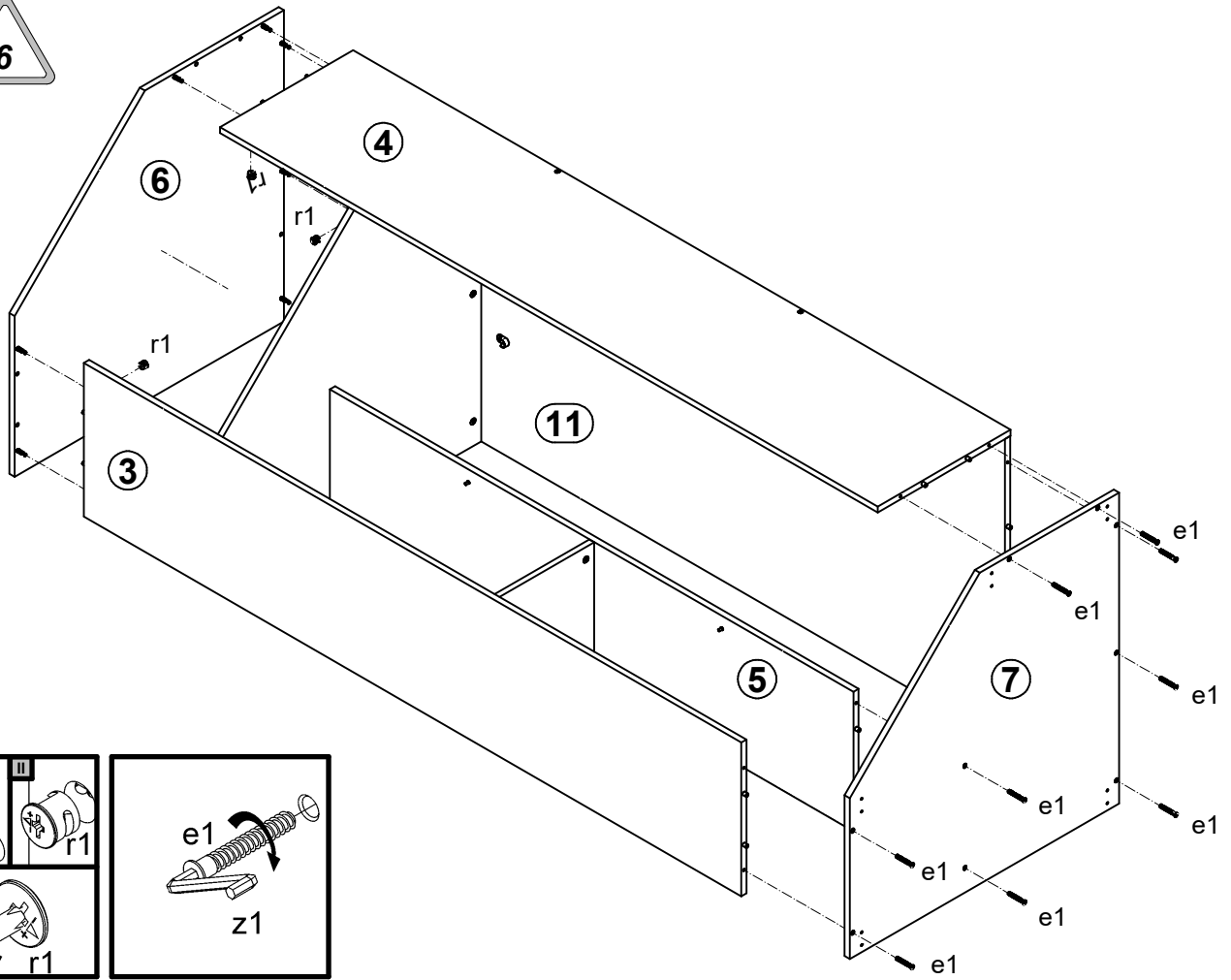

# 6

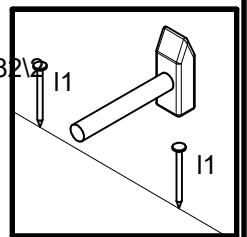
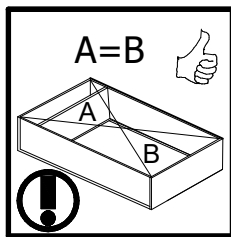
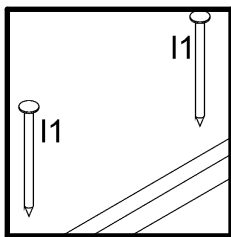
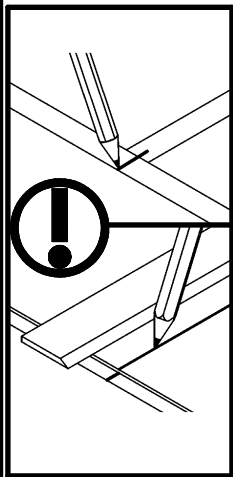
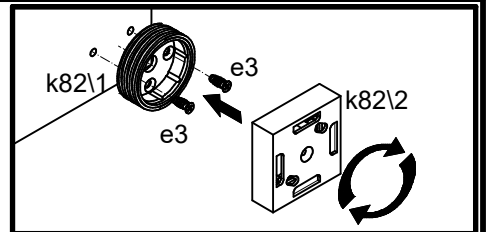
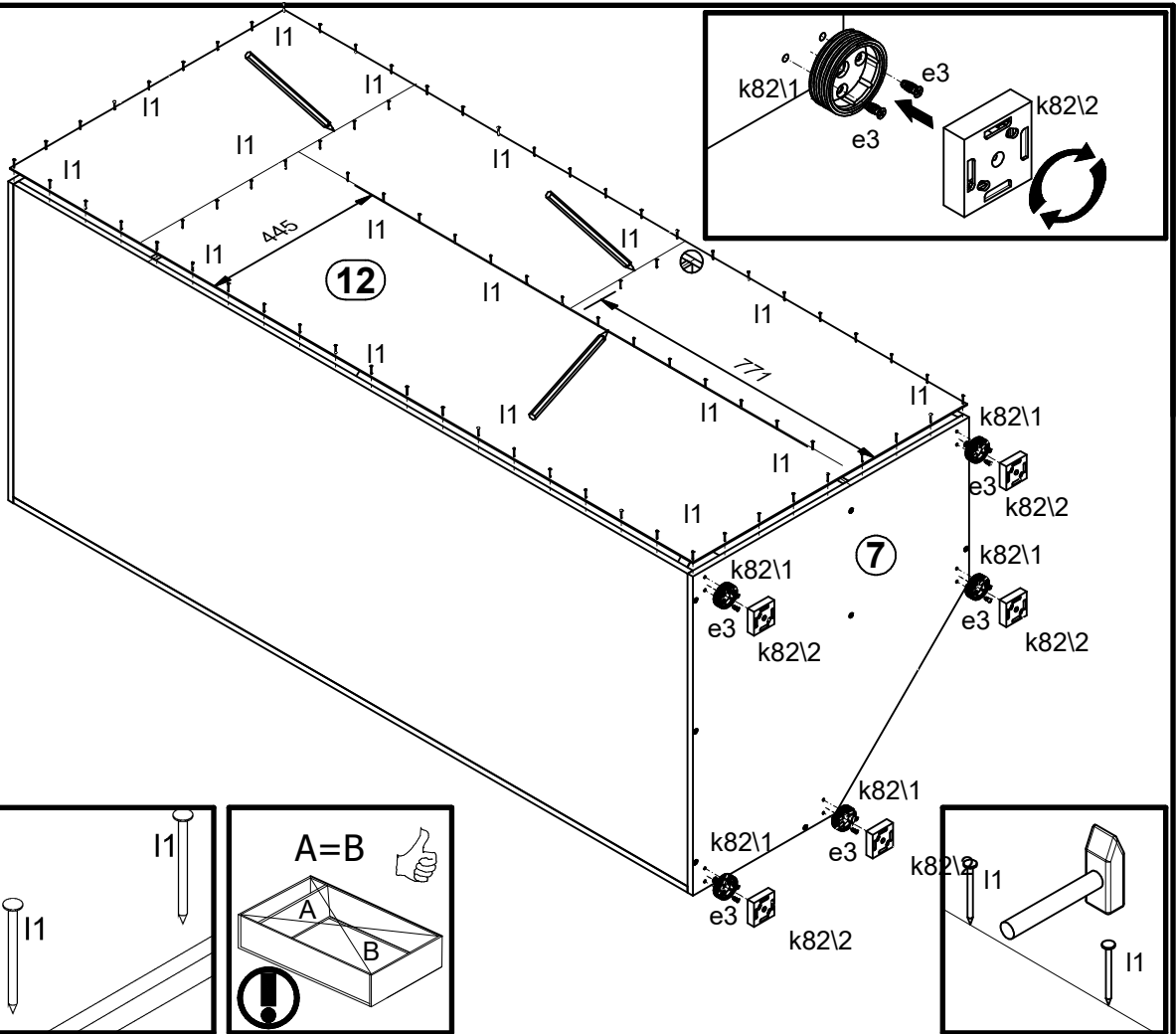

# 7A

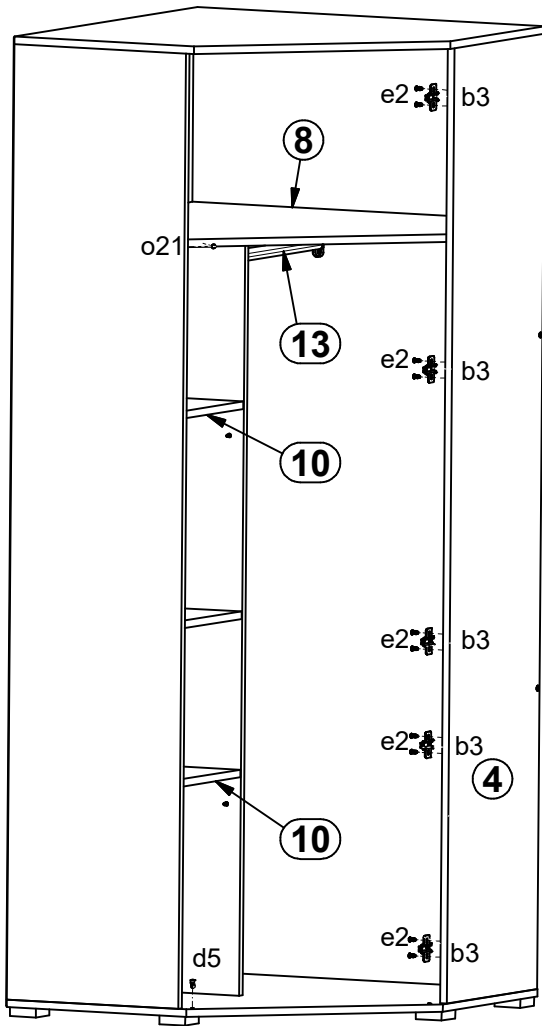

# 7B

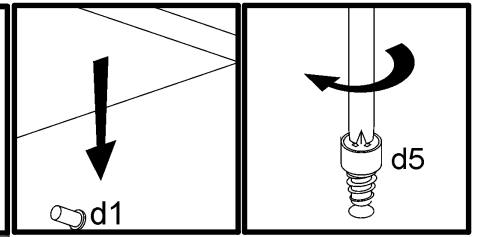
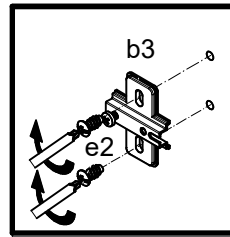
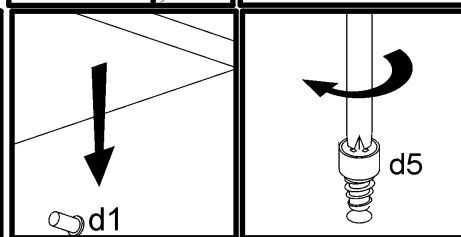
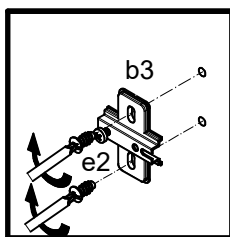
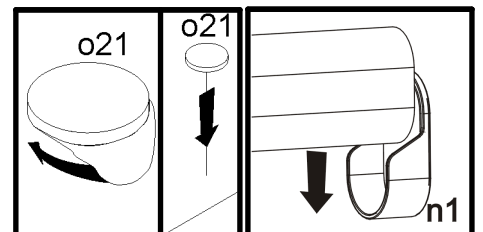
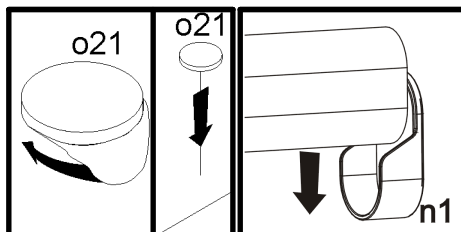
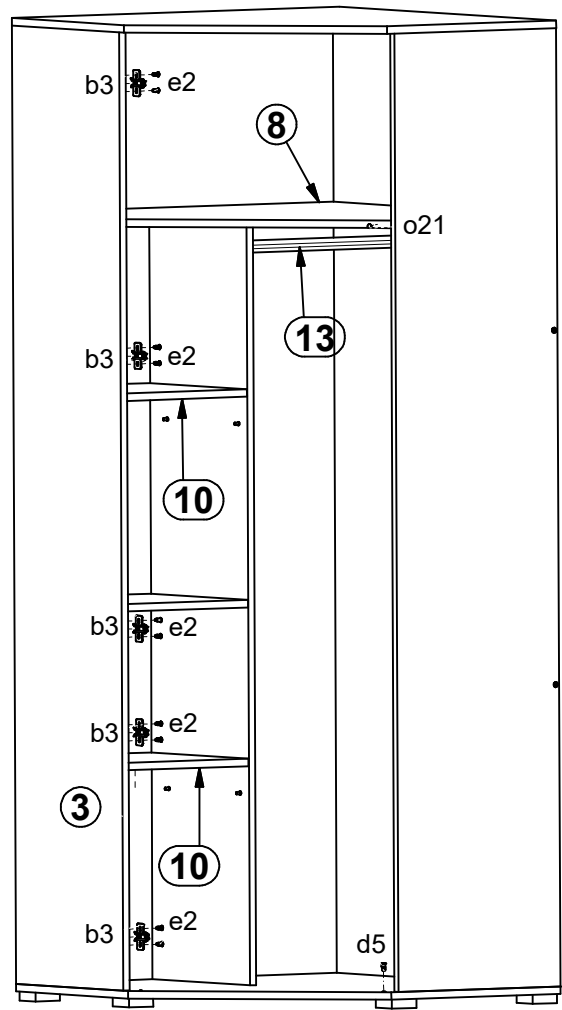

# 8A

# 8B

